

BODY • TABLE OF CONTENTS

Body

Single Fender	I-2
Tandem Straight Fender	I-2
Tandem Double Square Broke Fender	I-2
Tandem Tear Drop Fender	I-3
Triple Tear Drop Fender	I-3
Fender Backs	I-3
Gravel Guard	I-4
Edge Guard	I-4
Weather Seal	I-4
Rubber Bumpers	I-4
Wall Matt	I-4
Ramp Mat	I-4
Rubber Matting	I-5
Water Caddy	I-5
Mudflaps	I-5
Ramps.....	I-6
Trailer Gate Assist.....	I-6
Ramp Gates	I-7
Ramp Gate Parts.....	I-7
Ramp Gate Hardware Kits	I-7
Ramp Springs.....	I-7
Ventilation.....	I-8
A/C Units	I-9
Dump Tarps.....	I-10
Storage	I-10
Dump Tarp Replacement Parts.....	I-11
Tool Boxes.....	I-12
Hydraulic Hoist Kits and Power Units	I-13
Hydraulic Replacement Parts.....	I-20
Battery Accessories.....	I-21
Decals.....	I-21
Bonding Tape	I-23
Dump Conversion Hoists & Subframes.....	I-24

BODY • FENDERS

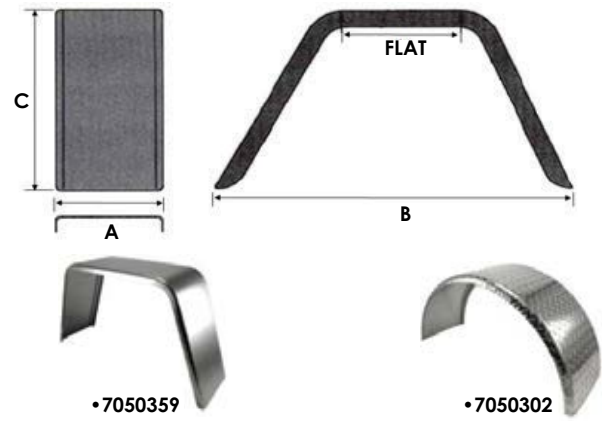
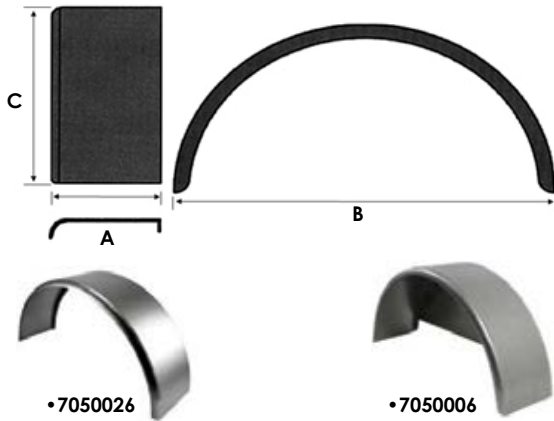

SINGLE FENDER								
ITEM NO.	A	B	C	RADIUS	WHEEL SIZE	MATERIAL	DESCRIPTION	USE BACK
7050022	8	28	10	1" FRONT 90° FLANGED BACK	13"-14"	16 ga. STEEL		7050005
7050026	9	32	15	1" FRONT 90° FLANGED BACK	14"-15"	16 ga. STEEL		7050058
7050006	9	32	16	1" FRONT 90° FLANGED BACK	14"-15"	16 ga. STEEL	WELDED BACK	-
7050075	9	32	15	1" FRONT 90° FLANGED BACK	14"-15"	14 ga. STEEL	TREAD PLATE	7050058
7050149	9	32	15	1" FRONT 90° FLANGED BACK	14"-15"	.060 ALUMINUM		
7050236	9	32	15	1" FRONT 90° FLANGED BACK	14"-15"	.063 ALUMINUM	TREAD PLATE	
7050029	9	36	18	1" FRONT 90° FLANGED BACK	14"-15"	16 ga. STEEL		-
7050009	10.75	32	16	1" FRONT 90° FLANGED BACK	14"-15"	16 ga. STEEL		7050058
7050010	10.75	36	18	1" FRONT 90° FLANGED BACK	16"	16 ga. STEEL		-
7050028	9	32	13	JEEP STYLE .625" BOTH SIDES	14"-15"	16 ga. STEEL		7050065
7050347	10	32	13	JEEP STYLE .625" BOTH SIDES	16"	.063 ALUMINUM	TREAD PLATE	7050065
7050008	10	33	14	JEEP STYLE .625" BOTH SIDES	16"	16 ga. STEEL		-
7050359	10	33	16.5	JEEP STYLE .625" BOTH SIDES	16"	16 ga. STEEL		-
7050116	10	36	19.25	JEEP STYLE .625" BOTH SIDES	13"-15"	16 ga. STEEL		-
7050302	10	32	16	RADIUS BOTH SIDES	14"-15"	.100 ALUMINUM		-

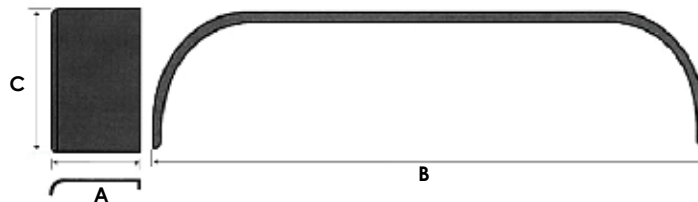

TANDEM STRAIGHT FENDER								
ITEM NO.	A	B	C	RADIUS	WHEEL SIZE	MATERIAL	DESCRIPTION	USE BACK
7050030	9	66	19.5	1" FRONT 90° FLANGED BACK	14"-15"	16 ga. STEEL		
7050034	9	72	20.5	1" FRONT 90° FLANGED BACK	15"-16"	16 ga. STEEL		7050061
7050002	9	72	21	1" FRONT 90° FLANGED BACK	15"-16"	16 ga. STEEL	WELDED BACK	-
7050032	9	72	20	1" FRONT 90° FLANGED BACK	15"-16"	14 ga. STEEL	TREAD PLATE	
7050041	10.75	72	20.5	1" FRONT 90° FLANGED BACK	15"-16"	16 ga. STEEL		

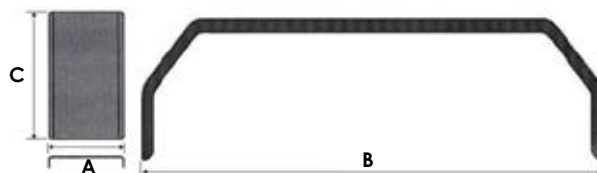

TANDEM DOUBLE SQUARE BROKE STRAIGHT FENDER								
ITEM NO.	A	B	C	RADIUS	WHEEL SIZE	MATERIAL	DESCRIPTION	USE BACK
7050085	9	72	17	1" FRONT 90° FLANGED BACK	15"-16"	14 ga. STEEL	TREAD PLATE	7050059

BODY • FENDERS

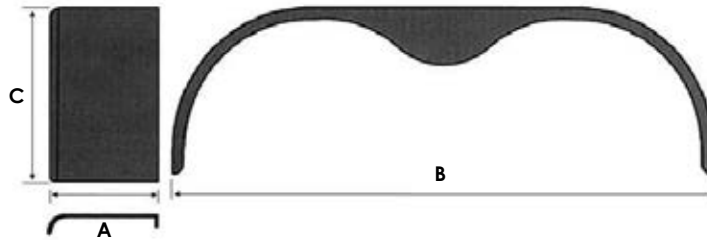

TANDEM TEAR DROP FENDER								
ITEM NO.	A	B	C	RADIUS	WHEEL SIZE	MATERIAL	DESCRIPTION	USE BACK
7050052	9	66	18	1" FRONT 90° FLANGED BACK	14"-15"	16 GA. STEEL		
7050055	9	72	21	1" FRONT 90° FLANGED BACK	15"-16"	16 GA. STEEL		7050061
7050001	9	72	21	1" FRONT 90° FLANGED BACK	15"-16"	16 GA. STEEL	WELDED BACK	-
7050054	9	72	20	1" FRONT 90° FLANGED BACK	15"-16"	14 GA. STEEL	TREAD PLATE	7050062
7050076	9	72	20.5	1" FRONT 90° FLANGED BACK	15"-16"	.100 ALUMINUM	TREAD PLATE	
7050045	10.75	72	21	1" FRONT 90° FLANGED BACK	15"-16"	16 GA. STEEL		
7050044	10.75	72	20.5	1" FRONT 90° FLANGED BACK	15"-16"	14 GA. STEEL	TREAD PLATE	
7050303	10	68	17	.625" BOTH SIDES	14"-15"	.100 ALUMINUM	TREAD PLATE	-
7050261	10.75	72	18	1" FRONT 90° FLANGED BACK	14"-15"	.063 ALUMINUM	TREAD PLATE	

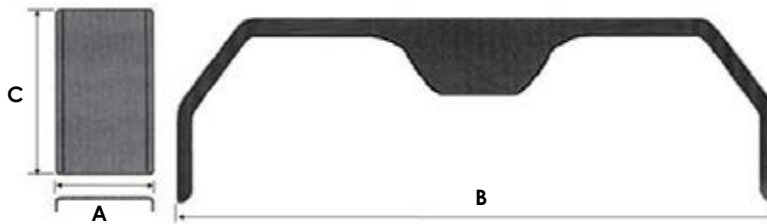

TANDEM TEAR DROP FENDER • DOUBLE SQUARE BROKE								
ITEM NO.	A	B	C	RADIUS	WHEEL SIZE	MATERIAL	DESCRIPTION	USE BACK
7050036	9	72	17	1" FRONT 90° FLANGED BACK	15"-16"	14 GA. STEEL	TREAD PLATE	7050059
7050042	10.75	72	17	1" FRONT 90° FLANGED BACK	15"-16"	14 GA. STEEL	TREAD PLATE	7050059

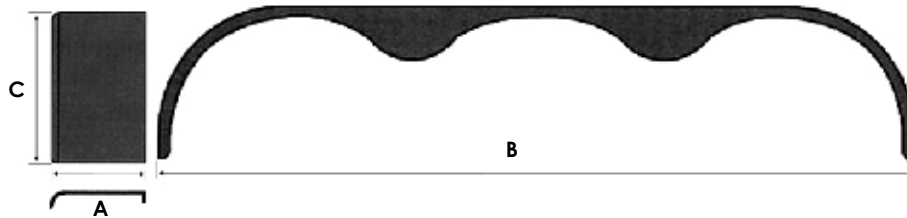

TRIPLE TEAR DROP FENDER								
ITEM NO.	A	B	C	RADIUS	WHEEL SIZE	MATERIAL	DESCRIPTION	USE BACK
7050049	9	108	21	1" FRONT 90° FLANGED BACK	15"-16"	16 GA. STEEL		
7050050	9	108	21	1" FRONT 90° FLANGED BACK	15"-16"	14 GA. STEEL	TREAD PLATE	
7050040	10.75	108	20.5	1" FRONT 90° FLANGED BACK	15"-16"	16 GA. STEEL		
7050304	10	102	18	.625" BOTH SIDES	14"-15"	.100 ALUMINUM	TREAD PLATE	-
7050306	12	110	18	.625" BOTH SIDES	14"-15"	.100 ALUMINUM	TREAD PLATE	-

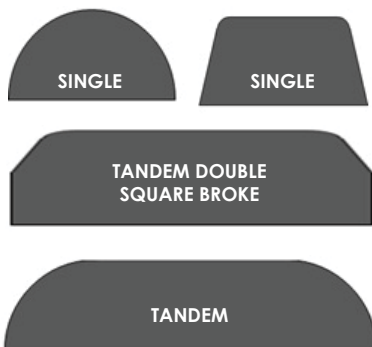

FENDER BACKS						
ITEM NO.	WIDTH	LENGTH	MATERIAL	DESCRIPTION	SIZE	
7050065	10.5	29.75	18 GA. STEEL	JEEP STYLE	SINGLE	
7050005	8.5	27	18 GA. STEEL	RADIUS	SINGLE	
7050058	12	31	16 GA. STEEL	RADIUS	SINGLE	
7050061	12	69	18 GA. STEEL	RADIUS	TANDEM	
7050062	12	69	14 GA. STEEL	RADIUS/TREAD PLATE	TANDEM	
7050067	12	72	18 GA. STEEL	DOUBLE SQUARE BROKE	TANDEM	
7050143	12	72	14 GA. STEEL	DBL SQU BROKE/TREAD PLATE	TANDEM	
7050087	12	34.5	18 GA. STEEL	RECTANGULAR	SINGLE	
7050063	12	69	18 GA. STEEL	RECTANGULAR	TANDEM	
7050089	12	105	18 GA. STEEL	RADIUS	TRIPLE	

BODY • GUARDS, SEALS & MATS



GRAVEL GUARD

ITEM NO.	DESCRIPTION	UNIT OF MEASURE
7500193	7" GRAVEL GUARD	SOLD BY THE FOOT
6800053	FENDER GRAVEL GUARD 7"X16"	SOLD BY THE EACH



HOT MELT ADHESIVE

EDGE GUARD

ITEM NO.	A	DESCRIPTION	REF NO.	UNIT OF MEASURE
7500015	1/8"	EDGE TRIM	1	SOLD BY THE FOOT
7500182	3/16"	EDGE TRIM	1	SOLD BY THE EACH
7500008	1/8"	EDGE TRIM CHROME	2	SOLD BY THE EACH

WEATHER SEAL

ITEM NO.	TYPE	HEIGHT	WIDTH	UNIT OF MEASURE
9910039	"D" BULB	9/16"	3/4"	SOLD BY THE FOOT

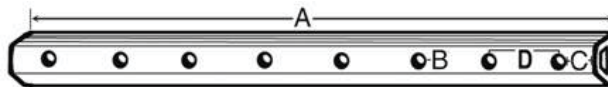
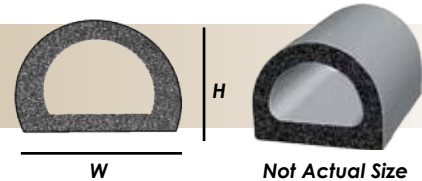

RUBBER BUMPERS

ITEM NO.	TYPE	B	A	D	C
7500237	BUMPER	3/8"	96"	11-1/2"	2"
7500009	BUMPER	9/16"	96"	11"	3"



WALL MAT

ITEM NO.	TYPE	WIDTH	THICK	UNIT OF MEASURE
8700020	TEXTURED	31"	3/16"	SOLD BY THE FOOT
8700037	TEXTURED	48"	3/16"	SOLD BY THE FOOT

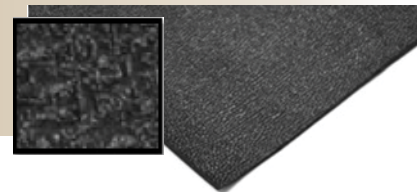

RAMP MAT

ITEM NO.	TYPE	WIDTH	THICK	UNIT OF MEASURE
8700028	ROUGH TOP	31"	3/16"	SOLD BY THE FOOT



Wall rubber, ramp rubber, and rubber bumpers are specifically designed to protect both horse and trailer.

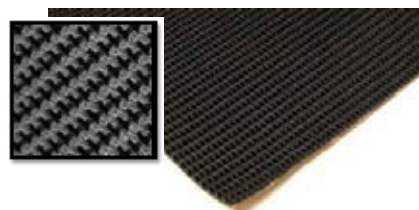

BODY • MATTING & MUDFLAPS

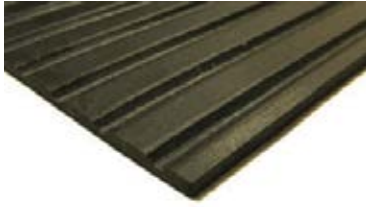

• 7500058



• 7500059



•8900026

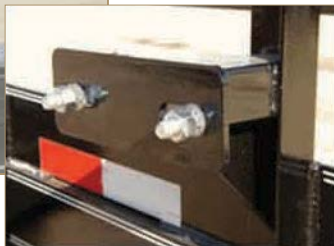

•8900004

RUBBER MATTING • ROLLED

ITEM NO.	TYPE	WIDTH	THICK	UNIT OF MEASURE
8700001	RIBBED	28"	5/16"	SOLD BY THE FOOT
8700002	RIBBED	30"	5/16"	SOLD BY THE FOOT
8700003	RIBBED	34"	5/16"	SOLD BY THE FOOT
8700004	RIBBED	36"	5/16"	SOLD BY THE FOOT

RUBBER MATTING • PRE CUT

ITEM NO.	TYPE	WIDTH	LENGTH	THICK
8700018	DIAMOND	48"	72"	1/2"
8700031	SMOOTH	34"	82"	1/2"
8700016	SMOOTH	48"	71"	1/2"
8700041	SMOOTH	48"	72"	1/2"
8700010	SMOOTH	48"	84"	1/2"
8700013	SMOOTH	48"	96"	1/2"
8700007	SMOOTH	60"	84"	1/2"

WATER CADDY

ITEM NO.	DESCRIPTION
7500059	25-GALLON WATER CADDY 14.5" X 56"
7500058	WATER CADDY STAND W/ STORAGE

MUDFLAPS

REF NO.	ITEM NO.	TYPE	WIDTH	LENGTH	THICK
-	8300002	BT LOGO	12"	18"	
-	8300020	CM LOGO	12"	18"	
1	8300004	NO LOGO	19"	24"	
2	8300003	BT LOGO	19"	24"	5/16"
3	8300018	CM LOGO	19"	24"	5/16"
-	8300005	NO LOGO	24"	30"	5/16"
4	8300021	CM SINGLE WHEEL KIT - INCLUDES STRAP, BRACKET & FLAP			
-	8300011	SINGLE WHEEL STRAP - REPLACEMENT			
-	8300009	SINGLE WHEEL BRACKET - REPLACEMENT			
5	8300019	CM DUAL WHEEL KIT - INCLUDES STRAP, BRACKET & FLAP			
6	8300010	DUAL WHEEL STRAP - REPLACEMENT			
7	8300008	DUAL WHEEL BRACKET - REPLACEMENT			
-	7030012	MUD FLAP CARRIAGE BOLT			
-	9000385	MUD FLAP NUT			

SPARE TIRE MOUNTS

ITEM NO.	DESCRIPTION
8900026	STAKE POCKET SPARE MOUNT
8900004	WELD-ON SPARE TIRE MOUNT

See Page E-27 for more spare tire mounts.

BODY • RAMPS & GATE ASSIST



TYPE 1



TYPE 2



TYPE 3



TYPE 4



TYPE 5



TYPE 6

RAMPS						
TYPE	ITEM NO.	DESCRIPTION	WIDTH	LENGTH	FINISH	
1	7180039	CHANNEL RAMP (3")	15"	48"	POWDER COAT	
2	7180043	CHANNEL RAMP (3") W/HOOKS	15"	60"	ENAMEL PAINT	
2	7180007	CHANNEL RAMP (3") W/HOOKS	15"	87"	POWDER COAT	
2	7180013	CHANNEL RAMP (3") W/HOOKS	15"	96"	ENAMEL PAINT	
3	7180008	FOLD UP RAMP W/ KNEE (5350499)	15"	60"	ENAMEL PAINT	
4	7180022	DIAMOND PLATE RAMP	20"	60"	ENAMEL PAINT	
4	7180014	DIAMOND PLATE RAMP	20"	96"	ENAMEL PAINT	
5	7180009	FOLD UP RAMP - HD	18.5"	60"	ENAMEL PAINT	
5	7180066	FOLD UP RAMP - LOW PROFILE HD	15"	60"	ENAMEL PAINT	
5	7180091	FOLD UP RAMP - LOW PROFILE 3/16" SIDES	15"	60"	ENAMEL PAINT	
6	7180313	ANGLE RAMP	15"	60"	ENAMEL PAINT	

TRAILER GATE ASSIST		
REF NO.	ITEM NO.	DESCRIPTION
1	8290217	GORILLA LIFT RAMPGATE ASSIST
2	7180120	RACK'EM DOUBLE BARRELL LIFT GATE ASSIST
3	7300017	GAS LIFT SPRING 186 LB ASSIST
4	7300044	13MM BALL STUD
5	7300010	RETAINING CLIP
6	5350375	BRACKET FOR GAS SPRING - WELD ON



1 GORILLA-LIFT



3

4



5



1-7/8"

6

2-7/8"



2

BODY • RAMP GATES & PARTS



RAMP GATES						
REF NO.	ITEM NO.	DESCRIPTION	WIDTH	LENGTH	FINISH	
1	7180018	RAMP GATE	60"	51"	BLACK	
2	7180019	RAMP GATE	77"	51"	BLACK	
-	7180017	RAMP GATE	83"	51"	BLACK	
3	7180023	INTEGRATED RAMP	83"	51"	BLACK	

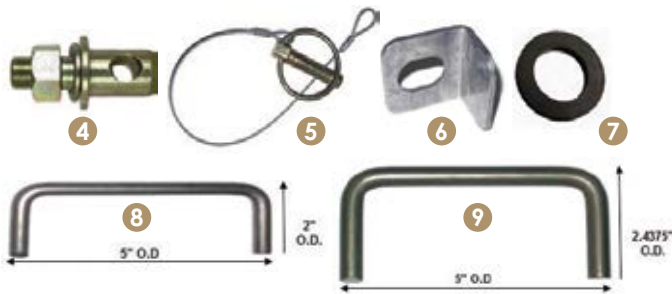

RAMP GATE PARTS		
REF NO.	ITEM NO.	DESCRIPTION
4	7300031	RAMP GATE PIN 7/8" SHAFT
5	7300030	LINCH PIN WITH 10" LANYARD
6	5350061	GATE BRACKET
7	7300043	ANTI RATTLE WASHER
8	5350719	GATE HANDLE 3/8" X 5"
9	5350605	GATE HANDLE 7/16" X 5"



RAMP GATE HARDWARE KITS		
REF NO.	ITEM NO.	DESCRIPTION
10	7030360	HARDWARE KIT FOR FOLDING RAMP GATES
11	7180036	HARDWARE KIT FOR 7180008
12	7180025	HARDWARE KIT FOR TYPE 5 RAMPS

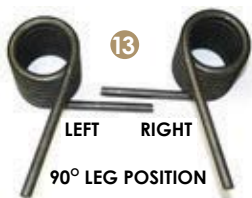

RAMP SPRINGS							
REF NO.	ITEM NO.	DESCRIPTION	DEGREE	SHAFT	ARM	DIA.	
13	7180085	OFFSET 7-COIL	90	1-1/2"	LH	0.375	
13	7180086	OFFSET 7-COIL	90	1-1/2"	RH	0.375	
14	7180151	STRAIGHT 7-COIL	180	1-1/2"	LH	0.468	
14	7180150	STRAIGHT 7-COIL	180	1-1/2"	RH	0.468	
14	7180152	STRAIGHT 7-COIL	180	2"	LH	0.500	
14	7180153	STRAIGHT 7-COIL	180	2"	RH	0.500	
14	8600096	STRAIGHT 6-COIL	180	1-1/2"	LH	0.500	
14	8600095	STRAIGHT 6-COIL	180	1-1/2"	RH	0.500	
15	8600006	DOUBLE TORSION	180	1-3/4"	-	0.375	
15	8600007	DOUBLE TORSION	180	1-3/4"	-	0.437	
16	8600091	BENT 6-COIL	-	1-1/2"	LH	0.500	
16	8600089	BENT 6-COIL	-	1-1/2"	RH	0.500	

BODY • VENTILATION =

VENTS

REF NO.	ITEM NO.	DESCRIPTION
1	7500057	BUTTERFLY VENT 7-1/2" DIA. ALUMINUM
2	7500055	POP-UP 2-WAY VENT BLACK - STEEL WITH GASKET
3	7500215	TRIM RING FOR POP-UP VENT BLACK ABS PLASTIC
4	7500061	POP-UP 2-WAY VENT - ALUMINUM WITH GASKET
5	6650776	EXTERIOR VENT (HALF MOON) WHITE
6	6650782	INTERIOR VENT FOR 3" HOLE WHITE
7	6650758	EXTERIOR VENT (HALF MOON) BLACK
8	6650771	INTERIOR VENT FOR 3" HOLE BLACK



ROOF VENTS

REF NO.	ITEM NO.	DESCRIPTION
9	8290145	VENT MAXX AIR DOME
9	8290756	VENT MAXX AIR DOME SMOKE
9	8290763	VENT MAXX AIR DOME BLACK
10	8290146	VENT MAXX AIR II DOME
11	8290098	DOME VENT 14 X 14 WHITE COVER
12	8290097	DOME VENT 14 X 14 METAL COVER
13	8290003	DOME VENT 14 X 14 WHITE COVER WITH 12V FAN WHITE
14	7500323	COVER WHITE - REPLACEMENT "NEW WEDGE"
15	8720026	COVER SMOKE - REPLACEMENT "NEW WEDGE"
16	8290004	COVER LOW PROFILE METAL - REPLACEMENT
17	8290006	VENT INTERIOR GARNISH - WHITE 1-7/8"-3" ROOF THICKNESS
18	8290005	COVER WHITE - REPLACEMENT "OLD DOME" STYLE
19	8720010	FAN 6" HD 12V 2-SPEED CHROME WITH BASE



BODY • A/C UNITS =



A/C UNITS		
REF NO.	ITEM NO.	DESCRIPTION
1	7330103	ROOF AC UNIT 13.5K MACH 3 PLUS
2	7330104	ROOF AC UNIT 15K MACH 15
3	7330105	CEILING UNIT FOR BOTH THE 7330103 & 7330104
4	7330131	HEAT STRIP 5.6K FOR BOTH 7330103 & 7330104

TT Part Number 7330103
MFG. Part No.:48203C966/48203C866/48203-876

MACH 3 PLUS™ RV AIR CONDITIONER

Now Charged With (Eco-Friendly) R-410A

The Mach 3 PLUS™ RV Air Conditioner's powerful compressor has a nominal cooling capacity of 13,500 BTU and a 320 CFM (cubic feet per minute) airflow.

MACH 3 PLUS™ RV AC SPECIFICATIONS - 48203 SERIES

NOMINAL BTU COOLING CAPACITY	13,500
LOCKED ROTOR COOLING AMPS	63.0
RUNNING WATTS/COOLING 1	1,650
RUNNING WATTS/COOLING 2	1,900
RUNNING WATTS/HEATING 3	1,800
ELECTRICAL RATING	115V 60HZ 1 PHASE
DELIVERED BTU HEATING OUTPUT	5,600
APPROXIMATE FULL-LOAD AMPS/COOLING	15.3
APPROXIMATE FULL-LOAD AMPS/HEATING	16.0
EVAPORATOR AIR DELIVERY CFM (HIGH SPEED)	320
UNIT WEIGHT (LBS.)	79.5

Coleman-Mach

TT Part Number 7330104
MFG. Part No.:48204C866/48204C866/48204C966

MACH 15™ RV AIR CONDITIONER

Now Charged With (Eco-Friendly) R-410A

The Mach 15™ RV Air Conditioner's powerful compressor has a nominal cooling capacity of 15,000 BTU and a 320 CFM (cubic feet per minute) airflow.

MACH 15™ RV AC SPECIFICATIONS - 48204 SERIES

NOMINAL BTU COOLING CAPACITY	15,000
LOCKED ROTOR COOLING AMPS	63.0
RUNNING WATTS/COOLING	1,650
RUNNING WATTS/COOLING 2	1,900
RUNNING WATTS/HEATING 3	1,800
ELECTRICAL RATING	115V 60HZ 1 PHASE
DELIVERED BTU HEATING OUTPUT	5,600
APPROXIMATE FULL-LOAD AMPS/COOLING	15.3
APPROXIMATE FULL-LOAD AMPS/HEATING	16.0
EVAPORATOR AIR DELIVERY CFM (HIGH SPEED)	320
UNIT WEIGHT (LBS.)	79.5



3

Motor is mounted directly to the bulkhead to prevent distortion of the angle of the blower wheel and to ensure a free turning action. This fixes the motor's position in relation to the blower.

At 1/3 hp. the fan motor in the Mach 3 PLUS™ is the largest in the industry. It features a sealed shaft to protect against damage from the elements.

2 YEAR WARRANTY

Large evaporator and condenser coils with raised lance fins enhance the system's ability to dissipate heat.



4

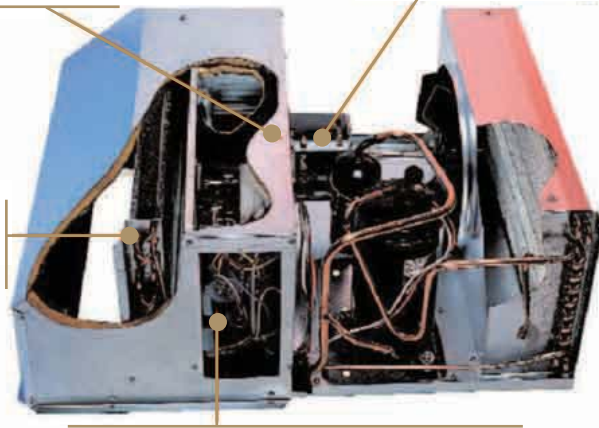

Start kit with start capacitors and PTCR device is standard equipment and makes starting easier under high temperature and humidity conditions.

BODY • TARPS & STORAGE

DUMP TARP KITS			
ITEM NO.	DESCRIPTION	WIDTH	LENGTH
6900203	DUMP TARP KIT MESH WITH HARDWARE	5'	12'
6900387	DUMP TARP KIT MESH WITH HARDWARE	5'	14'
6900201	DUMP TARP KIT MESH WITH HARDWARE	6'	14'
6900210	DUMP TARP KIT MESH WITH HARDWARE	6.5'	15'
6900144	DUMP TARP KIT MESH WITH HARDWARE	6.5'	18'
6900202	DUMP TARP KIT MESH WITH HARDWARE	7'	12'
6900209	DUMP TARP KIT MESH WITH HARDWARE	7'	15'
6900143	DUMP TARP KIT MESH WITH HARDWARE	7'	18'
6900217	DUMP TARP KIT MESH WITH HARDWARE	7'	20'
6900211	DUMP TARP KIT MESH WITH HARDWARE	7.5'	15'
6900134	DUMP TARP KIT MESH WITH HARDWARE	7.5'	18'
6900200	DUMP TARP KIT MESH WITH HARDWARE	8'	22'
6900208	REAR ANTI-SAIL TARP RETENTION BAR		
6900135	REPLACEMENT HANDLE		

REPLACEMENT TARPS			
ITEM NO.	DESCRIPTION	WIDTH	LENGTH
6900206	REPLACEMENT DUMP TARP KIT MESH	5'	12'
6900368	REPLACEMENT DUMP TARP KIT MESH	5'	14'
6900204	REPLACEMENT DUMP TARP KIT MESH	6'	14'
6900164	REPLACEMENT DUMP TARP KIT MESH	6.5'	15'
6900384	REPLACEMENT DUMP TARP KIT MESH	6.5'	18'
6900207	REPLACEMENT DUMP TARP KIT MESH	7'	12'
6900142	REPLACEMENT DUMP TARP KIT MESH	7'	15'
6900138	REPLACEMENT DUMP TARP KIT MESH	7'	18'
6900331	REPLACEMENT DUMP TARP KIT MESH	7'	20'
6900383	REPLACEMENT DUMP TARP KIT MESH	7'	22'
6900205	REPLACEMENT DUMP TARP KIT MESH	8'	22'

REPLACEMENT TARP STRAP	
ITEM NO.	DESCRIPTION
9250321	RUBBER STRAP 9"
9250322	RUBBER STRAP 15"
9250323	RUBBER STRAP 21"
9250324	RUBBER STRAP 31"

BED STEP	
ITEM NO.	DESCRIPTION
5430095	WELD -ON TRAILER BED STEP RAW STEEL



Storage

LANDSCAPE BOXES				
ITEM NO.	DESCRIPTION	HEIGHT	DEPTH	LENGTH
7180002	PAINTED BLACK - 5' TRAILER	24"	24"	64.5"
7180003	PAINTED BLACK - 6.5' TRAILER	24"	24"	81.5"
7180004	PAINTED BLACK - 7' TRAILER	24"	24"	87.5"

LANDSCAPE ACCESSORIES			
REF NO.	ITEM NO.	DESCRIPTION	ATTACHMENT
1	5350383	TRIMMER RACK-SOLD BY EACH	WELD-ON
2	7180034	TOOL RACK	WELD-ON
3	8900004	SPARE TIRE MOUNT	WELD-ON

• FOR BOLT ON ACCESSORIES SEE SECTION H

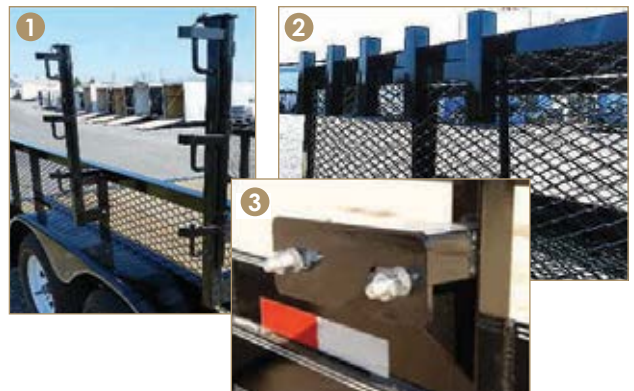

BODY • DUMP TARP REPLACEMENT PARTS

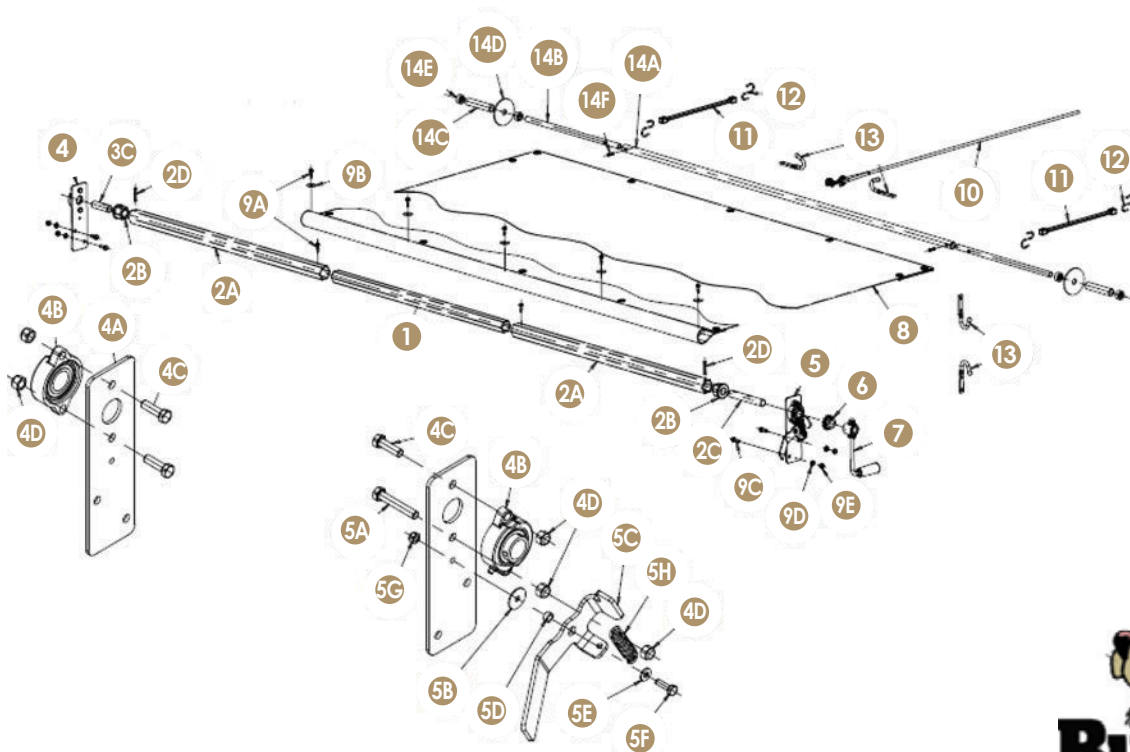

DUMP TARP REPLACEMENT PARTS

REF NO	ITEM NO.	QTY.	DESCRIPTION	REF NO	ITEM NO.	QTY.	DESCRIPTION
1	6900352	1	TUBE, INNER HEX	6	6900327	1	12-TOOTH SPROCKET
2	3008238	1	ROLL TUBE ASSY, ROADSIDE	7	6900135	1	CRANK HANDLE ASSY
2A	6900353	2	TUBE, OUTER HEX	8	-	1	REPLACEMENT TARP
2B	6900253	2	ADAPTOR SHAFT	9	6900313	1	HARDWARE BAG, TARP ROLLER KIT
2C	6900187	1	CRANK END SHAFT	9A	-	7	1/4" X 1" SELF-TAPPING SCREW
2D	-	2	SPRING ROLL PIN 5/16"	9B	-	5	FENDER WASHER 1/4", ZINC
3	3008239	1	ROLL TUBE ASSY, CURBSIDE	9C	-	4	CAP SCREW 3/8", ZINC
3C	3008181	1	IDLER END SHAFT	9D	-	4	LOCK WASHER 3/8", ZINC
4	6900271	1	BEARING BRACKET ASSY	9E	-	4	HEX NUT 3/8", ZINC
4A	6900346	2	TARP ROLL MOUNT BRACKET	10	3008225	1	PULL ROPE ASSY
4B	6900188	2	1" SELF-ALIGNING BEARING	11	TS15	2	TARP STRAP, 15" RUBBER
4C	-	3	3/8" CAP SCREW	12	9225	4	S-HOOK, TARP STRAP
4D	-	5	3/8" HEX LOCKING NUT	13	8850117	4	ROPE STORAGE HOOK
5	6900291	1	BEARING BRACKET ASSY, DETENT	14	6900208	-	REAR BAR KIT (OPTIONAL ACCESSORY)
5A	-	1	CAP SCREW 3/8", ZINC	14A	3008306	1	CENTER TUBE, REAR BAR KIT
5B	3009561	1	NYLON WASHER	14B	3008307	2	OUTER BAR, REAR BAR KIT
5C	6900416	1	DETENT LEVER	14C	3008308	2	PVC ROLLER TUBE, REAR BAR KIT
5D	6900326	1	SPACER BUSHING	14D	3008309	2	GUIDE WASHER, REAR BAR KIT
5E	-	1	FLAT WASHER 1/4", ZINC	14E	3013330	4	LOCK COLLAR, 20MM
5F	-	1	CAP SCREW 1/4", ZINC	14F	-	2	SPRING ROLL PIN 5/16"
5G	-	1	LOCK NUT 1/4", ZINC				
5H	3009434	1	EXTENSION SPRING				

BODY • TOOL BOXES



BRACKETS • 3" X 16" X 19"
SOLD AS LEFT HAND &
RIGHT HAND PAIR
9450007



ALL NEW Compression T-Handle Tool Boxes

■ Cam action Roller Engagement Compresses the Lid to Help Prevent Leaks

Our Doors Don't Rattle

Dimensions	Part Number
15X10X15.....	9450500-CT
15X10X24.....	9450501-CT
15X13X15.....	9450502-CT
15X13X24.....	9450503-CT
15X13X30.....	9450504-CT
15X13X36.....	9450505-CT
15X13X48.....	9450506-CT



UNDERBODY BOXES

ITEM NO.	DESCRIPTION	HEIGHT	DEPTH	LENGTH
9450312-CT	COMPRESSION LATCH BLACK	14"	16"	24"
9450311-CT	COMPRESSION LATCH BLACK	14"	16"	30"
9450014-CT	COMPRESSION LATCH BLACK	14"	16"	36"
9450500-CT	COMPRESSION LATCH BLACK	15"	10"	15"
9450501-CT	COMPRESSION LATCH BLACK	15"	10"	24"
9450502-CT	COMPRESSION LATCH BLACK	15"	13"	15"
9450503-CT	COMPRESSION LATCH BLACK	15"	13"	24"
9450504-CT	COMPRESSION LATCH BLACK	15"	13"	30"
9450505-CT	COMPRESSION LATCH BLACK	15"	13"	36"
9450506-CT	COMPRESSION LATCH BLACK	15"	13"	48"
9450009-CT	COMPRESSION LATCH BLACK	18"	18"	24"
9450060-CT	COMPRESSION LATCH BLACK	18"	18"	30"
9450008-CT	COMPRESSION LATCH BLACK	18"	18"	36"
9450018-CT	COMPRESSION LATCH BLACK	18"	18"	48"
9450004-CT	COMPRESSION LATCH BLACK	18"	18"	60"
8200388	REPLACEMENT T-HANDLE COMPRESSION LATCH			
8101248	LED TOOL BOX UTILITY LIGHT 12V WITH 3M ADHESIVE BACKING			
9450007	UNDERBODY BOX 18" MOUNTING BRACKETS			

TONGUE BOXES

REF NO.	ITEM NO.	DESCRIPTION	HEIGHT	DEPTH	LENGTH
1	9450419	ALUMINUM BOX .063 TP	15"	14.5"	22"/34"
2	9450289	STEEL BOX BLACK 12GA	16"	14.25"	21"/35"
3	9450115	POLYMER BOX HASP LOCK	18"	19"	18"/36"
4	8200399	REPLACEMENT LATCH (LOCKING) FOR EXCEPT 9450115			
5	9450156	PUMP BOX RAW STL NO LOCK	12"	21"	37"
-	9450215	PUMP BOX RAW STL NO LOCK	11"	18"	36"



4

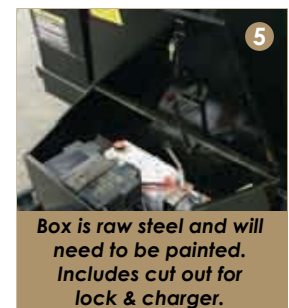

5



1



2



3

BODY • HYDRAULIC HOIST KITS & POWER UNITS

SCISSOR LIFT KITS	
ITEM NO.	DESCRIPTION
6900078	DUMP TRAILER HOIST PH-310
6900075	DUMP TRAILER HOIST PH-416
6900072	DUMP TRAILER HOIST PH-516
6900137	DUMP TRAILER HOIST PH-520
6900069	DUMP TRAILER HOIST PH-625
6900061	DUMP TRAILER HOIST PH-630

POWER UNITS			SINGLE	DOUBLE
ITEM NO.	DESCRIPTION	COMPATIBLE HOIST	ACTING	ACTING
6900141-01	4-QT 3200 PSI	PH-310 THRU 520		X
6900153	8-QT 3200 PSI	PH-310 THRU 520	X	
6900154	16-QT 3200 PSI	PH-625 & 630	X	
6900155	8-QT 3200 PSI	ALL		X

- POWER UNIT INCLUDES**
- Hydraulic Power Unit (HPU)
 - Hydraulic Hose Assembly
 - Hydraulic Fittings
 - Bridon Load Control



HOIST KIT INCLUDES

- Hoist Assembly (Frame & Cylinder)
- Safety Arm and Safety Arm Cup
- Safety Arm Storage Arm Bracket
- Hinges



SCISSOR LIFT HOIST

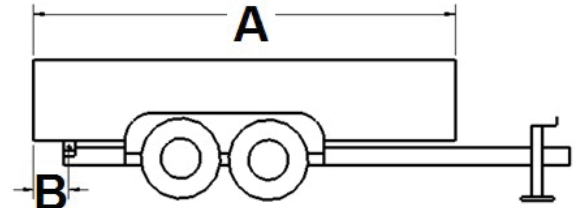

PH-310			
LENGTH	OVERHANG	DUMP ANGLE/TON	
"A"	"B"	45°	50°
7'	0"	3.2	2.9
8'	12"	3.8	3.4
9'	12"	3.1	2.9
9'	18"	3.8	3.4
9'	24"	4.5	4.1
10'	18"	3.2	2.9
10'	24"	3.8	3.4
10'	30"	4.5	4.1

PH-416			
LENGTH	OVERHANG	DUMP ANGLE/TON	
"A"	"B"	45°	50°
8'	12"	11.6	10.5
9'	12"	9.9	9
9'	18"	11.6	10.5
10'	12"	8.7	7.8
10'	18"	9.9	9
12'	12"	6.9	6.3
12'	18"	7.7	7
12'	24"	8.7	7.8

PH-516			
LENGTH	OVERHANG	DUMP ANGLE/TON	
"A"	"B"	45°	50°
10'	12"	9.6	8.7
10'	18"	11	9.9
10'	24"	12.8	1.6
12'	12"	7.6	6.9
12'	18"	8.5	7.7
12'	24"	9.6	8.7
14'	12"	6.4	5.8
14'	18"	6.9	6.3

PH-520			
LENGTH	OVERHANG	DUMP ANGLE/TON	
"A"	"B"	45°	50°
10'	12"	12.5	11.3
10'	18"	14.3	12.9
12'	12"	9.9	9
12'	18"	11.2	10.1
14'	12"	8.3	7.5
14'	18"	9	8.1
16'	12"	7.1	6.4
16'	18"	7.7	6.9

PH-625			
LENGTH	OVERHANG	DUMP ANGLE/TON	
"A"	"B"	45°	50°
14'	12"	11	10
14'	18"	12	10.9
14'	24"	13.3	12
16'	12"	9.5	8.6
16'	18"	10.2	9.2
16'	24"	11	10
18'	18"	8.8	8
18'	24"	9.5	8.6

PH-630			
LENGTH	OVERHANG	DUMP ANGLE/TON	
"A"	"B"	45°	50°
16'	12"	11.8	10.7
16'	18"	12.7	11.6
16'	24"	13.7	12.5
18'	18"	11	10.7
18'	24"	11.8	11.9
20'	18"	9.7	8.8
20'	24"	10.3	9.4



- Exclusive to our kits is a load control valve, which in the event of a hose failure, lowers the dump box at a controlled speed whether the box is empty or loaded. This exclusive valve simply installs into the port coming out of the pressure side of the hydraulic cylinder and the pressure hose attaches to the valve. Competitive systems use an inferior method of a small hole in a fitting to reduce the amount of fluid that can flow back into the tank.
- Power unit includes pressure balance gear pump which runs 10% more efficient than competing brands such as monarch.
- Motor has true positive and negative terminals verses grounding motor to trailer.
- Buy with assurance – factory warranty covers defects in workmanship, materials and design for a period of 2 years from the date of purchase. If purchased with a hoist kit the KTI warranty is extended to 3 years. Purchase the solar panel (6250004) the ac charger (6900317) hoist and power unit and extend the warranty to 5 years!

Premium 5 Year Warranty Available when purchased with solar panel and charger.



KTI recommends using a premium hydraulic oil to ensure optimum performance and system life. Select oil that has anti-wear properties, rust and oxidation inhibitors, foam inhibitors and good stability. Examples of premium grade hydraulic oils: Chevron Rando HDZ, Mobil DTE 10, DTE 20series, AMSOIL, and Shell Tellus. Automotive Transmission Oils are acceptable under normal conditions. Aviation Oils such as Valvoline ROYCO series or Mobil Aero HF or HFA may be used in prolonged, extreme cold environments. Do NOT use biodegradable hydraulic fluid. Do NOT mix oils.

BODY • POWER UNIT KITS =

DOUBLE ACTING POWER UNIT KITS



KTI Hydraulic Double Acting 12 VDC Dump Trailer pump Part #6900141-01

12V DC KTI Hydraulic Unit - 111 Power-Up / Power-Down; 2.0 GPM @1000PSI; 4 Quart Poly Tank

Based on the KTI Core circuit 111, this unit is the fastest, smoothest and most reliable Double-Acting 12VDC hydraulic pump available today! Each unit is assembled and tested with only the best quality components at the KTI, California facility. This unit is provided with 12 volt DC 4.5 inch motor, a 2P4W directional valve on top, and a 2P2W Single Load Holding Valve allowing smooth "Raise-Hold-Lower", with built in Patent pending PO check circuit, critical for dump trailers and hoists to ensure smooth lowering and no chatter. Our Version features A, B side ports allowing flexible hose connection. Pressure balanced gear pump design. Delivers superior performance and efficiency compared to competitive units that are not pressure balanced.

USE THIS POWER UNIT KIT WITH THE FOLLOWING HOIST KITS:

6900078 TB-8
6900075 TB-10

6900072 TB-12
6900137 TB-14

SPECIFICATIONS

- Double acting Power-Up / Power-Down
- 3200 PSI **UP** Relief Setting For Increased Lifting Power
- 1500 PSI Down Relief Setting "B" Port
- Lift, Hold and Lower circuit
- 2.0 GPM @ 1000 PSI nominal operation
- 4 Quart usable Translucent Reservoir
- #6 SAE O-Ring boss port "A" (top); "B" (bottom)
- Horizontal mount
- Hand held, two button pendant with 15 foot removable cord
- Pilot Operated check valve & NC2W for load holding in both directions

FEATURES AND BENEFITS

- Power unit includes pressure balance gear pump which runs 10% more efficient than competing brands such as Monarch.
- Exclusive to our kits is a Load Control Valve that lowers the dump box at a controlled speed whether the box is empty or over loaded in the event of a hose failure. The Load Control Valve simply installs into the the port coming out of the pressure (or load holding) side of the hydraulic cylinder and the pressure hose attaches to the valve. No additional plumbing is required as the external body of the valve is a standard hydraulic fitting. Most competitive systems use a small hole in a fitting to reduce the amount of fluid that can flow back into the tank.
- Motor has true positive and negative terminals versus grounding motor to trailer.
- Buy with assurance - Factory Warranty covers defects in workmanship, materials and design for a period of 2 years from date of purchase. If purchased with Power Hoist kit the KTI warranty gets extended to 3 years. Purchase a Solar Panel (6250004) plus AC charger (6900317) and extend warranty to 5 YEARS!

FLOW CURVE

2.7 gpm @ 500 psi
2.0 gpm @ 1000 psi
1.7 gpm @ 1500 psi
1.3 gpm @ 3000 psi

Flow curves such as this are typical with all power units of this nature, be it KTI or any Competitive unit.

POWER UNIT DIMENSIONS

Overall length 18.81 inches
Width 7.8 inches
Height 8.0 inches

6900141-01 DOUBLE ACTING PUMP KIT INCLUDES THE FOLLOWING

- Double Acting Pump - Relief Setting @3200psi, 4 Quart Poly Reservoir
- Hose Assy, 110" with 1) 90 degree #6 female JIC fitting and 1) straight #6 female JIC fitting
- Hose Assy, 120" with 2) straight #6 female JIC fittings
- Red Battery Cable, Black Battery Cable
- Load Control Valve
- Fitting, #6 SAE male X #6 JIC male 90 degree
- Fitting, #6 SAE male Breather

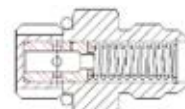

KTI recommends using a premium hydraulic oil to ensure optimum performance and system life. Select oil that has anti-wear properties, rust and oxidation inhibitors, foam inhibitors and good stability. Examples of premium grade hydraulic oils: Chevron Rando HDZ, Mobil DTE 10, DTE 20series, AMSOIL, and Shell Tellus. Automotive Transmission Oils are acceptable under normal conditions. Aviation Oils such as Valvoline ROYCO series or Mobil Aero HF or HFA may be used in prolonged, extreme cold environments. Do NOT use biodegradable hydraulic fluid. Do NOT mix oils.

BODY • POWER UNIT KITS =

DOUBLE ACTING POWER UNIT KITS



KTI Hydraulic Double Acting 12 VDC Dump Trailer pump Part #6900155

12V DC KTI Hydraulic Unit - 111 Power-Up / Power-Down; 2.0 GPM @1000PSI; 8 Quart Poly Tank

Based on the KTI Core circuit 111, this unit is the fastest, smoothest and most reliable Double-Acting 12VDC hydraulic pump available today! Each unit is assembled and tested with only the best quality components at the KTI, California facility. This unit is provided with 12 volt DC 4.5 inch motor, a 2P4W directional valve on top, and a 2P2W Single Load Holding Valve allowing smooth "Raise-Hold-Lower", with built in Patent pending PO check circuit, critical for dump trailers and hoists to ensure smooth lowering and no chatter. Our Version features A, B side ports allowing flexible hose connection. Pressure balanced gear pump design. Delivers superior performance and efficiency compared to competitive units that are not pressure balanced.

USE THIS POWER UNIT KIT WITH THE FOLLOWING HOIST KITS:

6900078	TB-8	6900137	TB-14
6900075	TB-10	6900069	TB-18
6900072	TB-12	6900061	TB-20

SPECIFICATIONS

- Double acting Power-Up / Power-Down
- 3200 PSI UP Relief Setting For Increased Lifting Power
- 1500 PSI Down Relief Setting "B" Port
- Lift, Hold and Lower circuit
- 2.0 GPM @ 1000 PSI nominal operation
- 8 Quart usable Translucent Reservoir
- #6 SAE O-Ring boss port "A" (top); "B" (bottom)
- Horizontal mount
- Hand held, two button pendant with 15 foot removable cord
- Pilot Operated check valve & NC2W for load holding in both directions

FEATURES AND BENEFITS

- Power unit includes pressure balance gear pump which runs 10% more efficient than competing brands such as Monarch.
- Exclusive to our kits is a Load Control Valve that lowers the dump box at a controlled speed whether the box is empty or over loaded in the event of a hose failure. The Load Control Valve simply installs into the the port coming out of the pressure (or load holding) side of the hydraulic cylinder and the pressure hose attaches to the valve. No additional plumbing is required as the external body of the valve is a standard hydraulic fitting. Most competitive systems use a small hole in a fitting to reduce the amount of fluid that can flow back into the tank.
- Motor has true positive and negative terminals versus grounding motor to trailer.
- Buy with assurance - Factory Warranty covers defects in workmanship, materials and design for a period of 2 years from date of purchase. If purchased with Power Hoist kit the KTI warranty gets extended to 3 years. Purchase a Solar Panel (6250004) plus AC charger (6900317) and extend warranty to 5 YEARS!

FLOW CURVE

2.7 gpm @ 500 psi
2.0 gpm @ 1000 psi
1.7 gpm @ 1500 psi
1.3 gpm @ 3000 psi

Flow curves such as this are typical with all power units of this nature, be it KTI or any Competitive unit.

POWER UNIT DIMENSIONS

Overall length 25.8 inches
Width 7.8 inches
Height 8.0 inches

6900155 DOUBLE ACTING PUMP KIT INCLUDES THE FOLLOWING

- Double Acting Pump - Relief Setting @3200psi, 8 Quart Poly Reservoir
- Hose Assy, 110" with 1) 90 degree #6 female JIC fitting and 1) straight #6 female JIC fitting
- Hose Assy, 120" with 2) straight #6 female JIC fittings
- Red Battery Cable, Black Battery Cable
- Load Control Valve
- Fitting, #6 SAE male X #6 JIC male 90 degree
- Fitting, #6 SAE male Breather

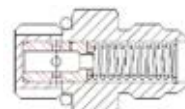

KTI recommends using a premium hydraulic oil to ensure optimum performance and system life. Select oil that has anti-wear properties, rust and oxidation inhibitors, foam inhibitors and good stability. Examples of premium grade hydraulic oils: Chevron Rando HDZ, Mobil DTE 10, DTE 20series, AMSOIL, and Shell Tellus. Automotive Transmission Oils are acceptable under normal conditions. Aviation Oils such as Valvoline ROYCO series or Mobil Aero HF or HFA may be used in prolonged, extreme cold environments. Do NOT use biodegradable hydraulic fluid. Do NOT mix oils.

BODY • HYDRAULIC REPLACEMENT PARTS

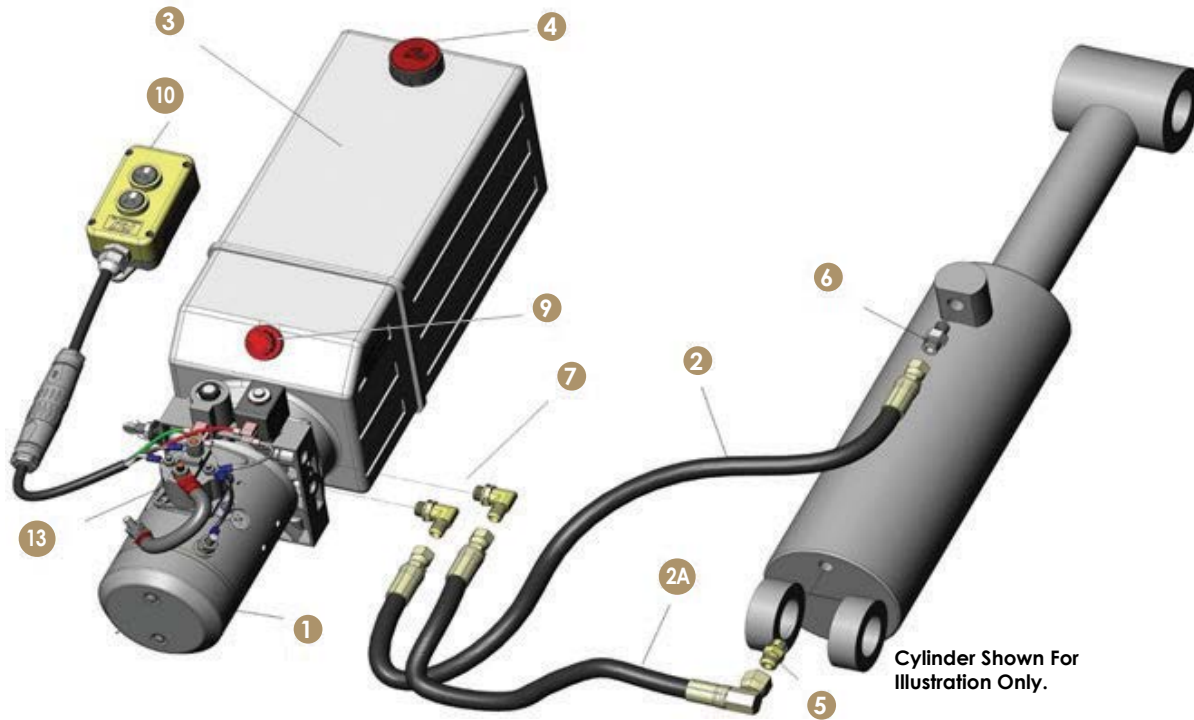

Cylinder Shown For Illustration Only.

REPLACEMENT PARTS FOR 6900155

REF NO.	ITEM NO.	DESCRIPTION
1	SPECIAL ORDER	DOUBLE ACTING PUMP - RELIEF SETTING @ 3200 PSI
2	6900301	HOSE ASSEMBLY - 110" 90° #6 FEMALE JIC FITTING & STRAIGHT #6 JIC FITTING
2A	6900302	HOSE ASSEMBLY - 120" STRAIGHT #6 JIC FITTING ON BOTH ENDS
-	6900274	4 QUART PLASTIC REPLACEMENT TANK FOR 6900141-01
3	6900304	8 QUART PLASTIC REPLACEMENT TANK FOR 6900153
-	6900305	O-RING (NOT SHOWN)
4	6900306	UPPER RESERVOIR DIP STICK CAP
5	6900310	LOAD CONTROL VALVE
6	6900240	FITTING - #6 SAE MALE X #6 JIC MALE 90°
7	6900239	FITTING - #6 SAE MALE X #6 JIC MALE STRAIGHT ADAPTOR
8	6900312	FITTING - #6 SAE MALE BREATHER
9	6900307	LOWER RESERVOIR CAP
10	-	REMOTE - SEE KTI REMOTES ON NEXT PAGE
13	6900041	STARTER SOLENOID

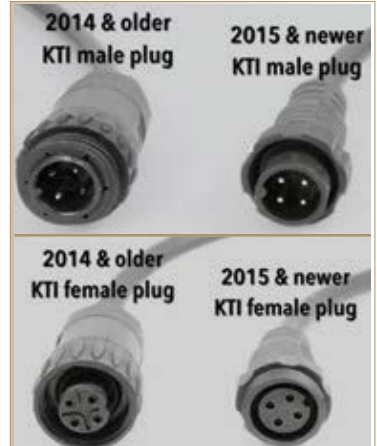

KTI switched to a quick connector in late 2015. The old style quick connector will no longer work on the new style. You will need all three new pieces to replace an old remote.

KTI recommends using a premium hydraulic oil to ensure optimum performance and system life. Select oil that has anti-wear properties, rust and oxidation inhibitors, foam inhibitors and good stability. Examples of premium grade hydraulic oils: Chevron Rando HDZ, Mobil DTE 10, DTE 20series, AMSOIL, and Shell Tellus. Automotive Transmission Oils are acceptable under normal conditions. Aviation Oils such as Valvoline ROYCO series or Mobil Aero HF or HFA may be used in prolonged, extreme cold environments. Do NOT use biodegradable hydraulic fluid. Do NOT mix oils.

BODY • POWER UNIT KITS =

SINGLE ACTING POWER UNIT KITS



KTI Hydraulic Single Acting 12 VDC Dump Trailer pump Part #6900153

12V DC KTI Hydraulic Unit - 103 Power-Up / Gravity-Down; 2.0 GPM @1000PSI; 8 Qt. Poly Tank

Based on the KTI Core circuit 103, this unit is the fastest, smoothest and most reliable Single-Acting 12VDC hydraulic pump available today! Each unit is assembled and tested with only the best quality components at the KTI, California facility. Unit provided with 12 volt DC 4.5 inch motor, Pressure (P) top port allowing flexible hose connection. Pressure balanced gear pump design. Delivers superior performance and efficiency compared to competitive units that are not pressure balanced.

USE THIS POWER UNIT KIT WITH THE FOLLOWING HOIST KITS:

6900078 TB-8
6900075 TB-10

6900072 TB-12
6900137 TB-14

SPECIFICATIONS

- Single acting Power-Up / Gravity -Down
- 3200 PSI **UP** Relief Setting For Increased Lifting Power
- Lift, Hold and Lower circuit
- 2.0 GPM @ 1000 PSI nominal operation
- 8 Quart usable Translucent Reservoir
- #6 SAE O-Ring boss port "P"
- Horizontal mount
- Hand held, two button pendant with 15 foot removable cord
- Product of California

FEATURES AND BENEFITS

- Power unit includes pressure balance gear pump which runs 10% more efficient than competing brands such as Monarch.
- Exclusive to our kits is a Load Control Valve that lowers the dump box at a controlled speed whether the box is empty or over loaded in the event of a hose failure. The Load Control Valve simply installs into the the port coming out of the pressure (or load holding) side of the hydraulic cylinder and the pressure hose attaches to the valve. No additional plumbing is required as the external body of the valve is a standard hydraulic fitting. Most competitive systems use a small hole in a fitting to reduce the amount of fluid that can flow back into the tank.
- Motor has true positive and negative terminals versus grounding motor to trailer.
- Buy with assurance - Factory Warranty covers defects in workmanship, materials and design for a period of 2 years from date of purchase. If purchased with Power Hoist kit the KTI warranty gets extended to 3 years. Purchase a Solar Panel (6250004) plus AC charger (6900317) and extend warranty to 5 YEARS!

FLOW CURVE

2.7 gpm @ 500 psi
2.0 gpm @ 1000 psi
1.7 gpm @ 1500 psi
1.3 gpm @ 3000 psi

Flow curves such as this are typical with all power units of this nature, be it KTI or any Competitive unit.

POWER UNIT DIMENSIONS

Overall length 25.8 inches
Width 7.8 inches

6900053 SINGLE ACTING PUMP KIT INCLUDES THE FOLLOWING

- Single Acting Pump - Relief Setting @3200psi, 8 Quart Poly Reservoir
- Hose Assy, 110" with 1) 90 degree #6 female JIC fitting and 1) straight #6 female JIC fitting
- Red Battery Cable, Black Battery Cable
- Load Control Valve
- Fitting, #6 SAE male X #6 JIC male 90 degree
- Fitting, #6 SAE male Breather

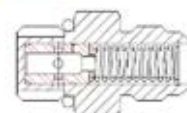

KTI recommends using a premium hydraulic oil to ensure optimum performance and system life. Select oil that has anti-wear properties, rust and oxidation inhibitors, foam inhibitors and good stability. Examples of premium grade hydraulic oils: Chevron Rando HDZ, Mobil DTE 10, DTE 20series, AMSOIL, and Shell Tellus. Automotive Transmission Oils are acceptable under normal conditions. Aviation Oils such as Valvoline ROYCO series or Mobil Aero HF or HFA may be used in prolonged, extreme cold environments. Do NOT use biodegradable hydraulic fluid. Do NOT mix oils.

BODY • POWER UNIT KITS =

SINGLE ACTING POWER UNIT KITS



KTI Hydraulic Single Acting 12 VDC Dump Trailer pump Part #6900154

12V DC KTI Hydraulic Unit - 103 Power-Up / Gravity-Down; 2.0 GPM @1000PSI; 4.0 Gal. Poly Tank

Based on the KTI Core circuit 103, this unit is the fastest, smoothest and most reliable Single-Acting 12VDC hydraulic pump available today! Each unit is assembled and tested with only the best quality components at the KTI, California facility. Unit provided with 12 volt DC 4.5 inch motor, Pressure (P) top port allowing flexible hose connection. Pressure balanced gear pump design. Delivers superior performance and efficiency compared to competitive units that are not pressure balanced.

USE THIS POWER UNIT KIT WITH THE FOLLOWING HOIST KITS:

6900078 TB-8
6900075 TB-20

SPECIFICATIONS

- Single acting Power-Up / Gravity -Down
- 3200 PSI **UP** Relief Setting For Increased Lifting Power
- Lift, Hold and Lower circuit
- 2.0 GPM @ 1000 PSI nominal operation
- 16 Quart usable Translucent Reservoir
- #6 SAE O-Ring boss port "P"
- Horizontal mount
- Hand held, two button pendant with 15 foot removable cord
- Product of California

FEATURES AND BENEFITS

- Power unit includes pressure balance gear pump which runs 10% more efficient than competing brands such as Monarch.
- Exclusive to our kits is a Load Control Valve that lowers the dump box at a controlled speed whether the box is empty or over loaded in the event of a hose failure. The Load Control Valve simply installs into the the port coming out of the pressure (or load holding) side of the hydraulic cylinder and the pressure hose attaches to the valve. No additional plumbing is required as the external body of the valve is a standard hydraulic fitting. Most competitive systems use a small hole in a fitting to reduce the amount of fluid that can flow back into the tank.
- Motor has true positive and negative terminals versus grounding motor to trailer.
- Buy with assurance - Factory Warranty covers defects in workmanship, materials and design for a period of 2 years from date of purchase. If purchased with Power Hoist kit the KTI warranty gets extended to 3 years. Purchase a Solar Panel (6250004) plus AC charger (6900317) and extend warranty to 5 YEARS!

FLOW CURVE

2.7 gpm @ 500 psi
2.0 gpm @ 1000 psi
1.7 gpm @ 1500 psi
1.3 gpm @ 3000 psi

Flow curves such as this are typical with all power units of this nature, be it KTI or any Competitive unit.

POWER UNIT DIMENSIONS

Overall length 22.5 inches
Width 7.8 inches
Height 10.0 inches

6900054 SINGLE ACTING PUMP KIT INCLUDES THE FOLLOWING

- Single Acting Pump - Relief Setting @3200psi, 16 Quart Poly Reservoir
- Hose Assy, 110" with 1) 90 degree #6 female JIC fitting and 1) straight #6 female JIC fitting
- Hose Assy, 120" with 2) straight #6 female JIC fittings
- Red Battery Cable, Black Battery Cable
- Load Control Valve
- Fitting, #6 SAE male X #6 JIC male 90 degree
- Fitting, #6 SAE male Breather

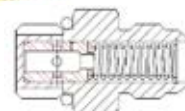

KTI recommends using a premium hydraulic oil to ensure optimum performance and system life. Select oil that has anti-wear properties, rust and oxidation inhibitors, foam inhibitors and good stability. Examples of premium grade hydraulic oils: Chevron Rando HDZ, Mobil DTE 10, DTE 20series, AMSOIL, and Shell Tellus. Automotive Transmission Oils are acceptable under normal conditions. Aviation Oils such as Valvoline ROYCO series or Mobil Aero HF or HFA may be used in prolonged, extreme cold environments. Do NOT use biodegradable hydraulic fluid. Do NOT mix oils.

BODY • HYDRAULIC REPLACEMENT PARTS

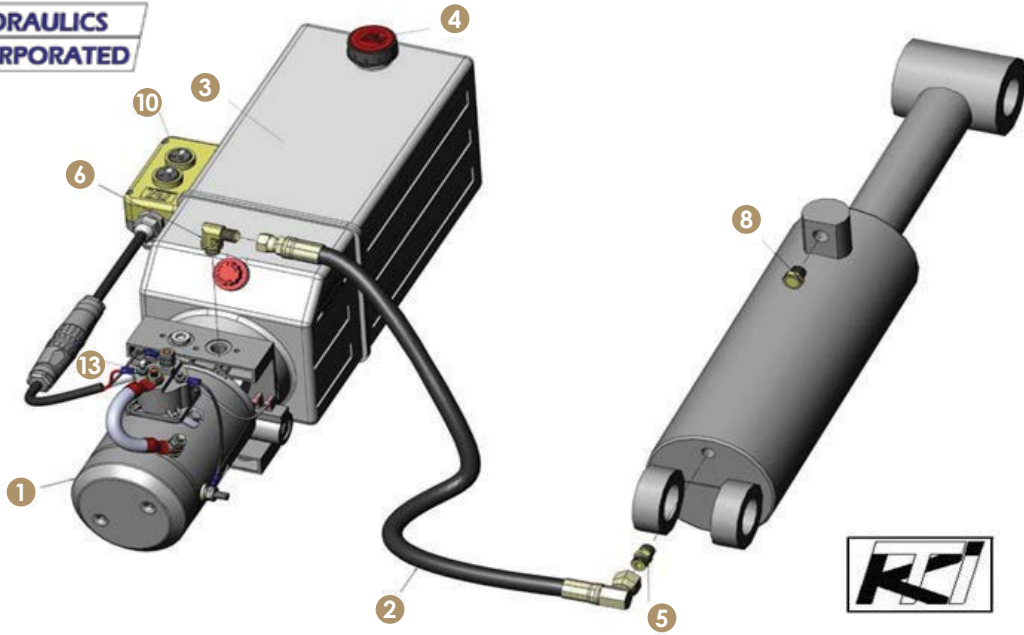

KTI switched to a quick connector in late 2015. The old style quick connector will no longer work on the new style. You will need all three new pieces to replace an old remote.

REPLACEMENT PARTS FOR 6900153

REF NO.	ITEM NO.	DESCRIPTION
1	SPECIAL ORDER	SINGLE ACTING PUMP - RELIEF SETTING @ 3200 PSI
2	6900301	HOSE ASSEMBLY - 110" 90° #6 FEMALE JIC FITTING & STRAIGHT #6 JIC FITTING
3	6900304	8 QUART PLASTIC REPLACEMENT TANK FOR 6900153
3	6900303	16 QUART PLASTIC REPLACEMENT TANK 6900154
-	6900305	O-RING (NOT SHOWN)
4	6900306	UPPER RESERVOIR DIP STICK CAP
5	6900310	LOAD CONTROL VALVE
6	6900240	FITTING - #6 SAE MALE X #6 JIC MALE 90°
8	6900312	FITTING - #6 SAE MALE BREATHER
-	6900307	LOWER RESERVIOR CAP
10	-	REMOTE - SEE KTI REMOTES ON NEXT PAGE
13	6900041	STARTER SOLENOID

REPLACEMENT PARTS FOR 6900154

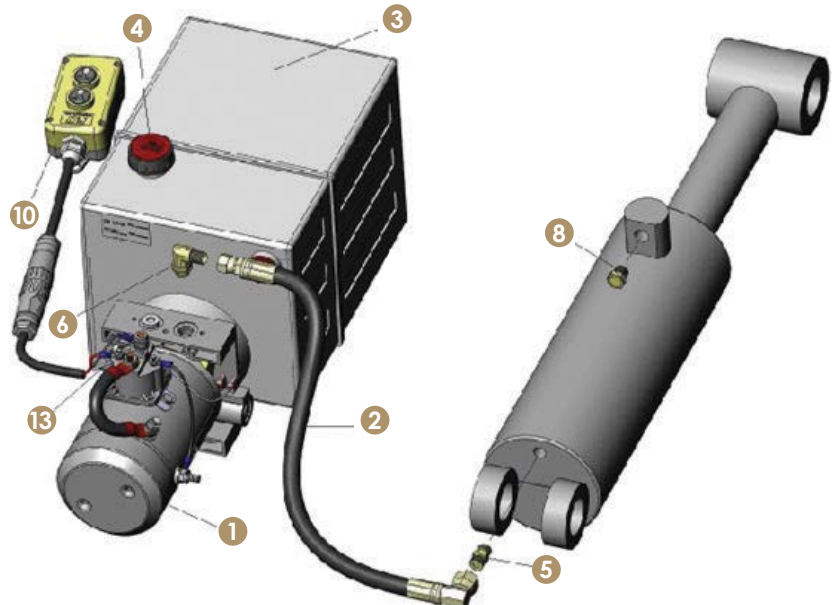

KTI recommends using a premium hydraulic oil to ensure optimum performance and system life. Select oil that has anti-wear properties, rust and oxidation inhibitors, foam inhibitors and good stability. Examples of premium grade hydraulic oils: Chevron Rando HDZ, Mobil DTE 10, DTE 20series, AMSOIL, and Shell Tellus. Automotive Transmission Oils are acceptable under normal conditions. Aviation Oils such as Valvoline ROYCO series or Mobil Aero HF or HFA may be used in prolonged, extreme cold environments. Do NOT use biodegradable hydraulic fluid. Do NOT mix oils.

BODY • HYDRAULIC REPLACEMENT PARTS

REMOTES						
REF NO.	ITEM NO.	DESCRIPTION	UP	DOWN	START	POWER
1	6900104	DUMP REMOTE - UNIVERSAL WIRELESS	-	-	-	-
2	6900319	DUMP REMOTE HARNESS DOUBLE ACTING 4-WIRE (KTI)	RED	GREEN	WHITE	BLACK
3	6900401	DUMP REMOTE HARNESS SINGLE ACTING 4-WIRE (KTI)	-	GREEN	RED	BLK/WHT
4	6900375	DUMP 15' EXTENSION CABLE (KTI)	-	-	-	-
5	6900400	DUMP REMOTE CONTROLLER WITH 10" OF CABLE (KTI)	-	-	-	-
6	6900059	DUMP REMOTE KG12 DOUBLE ACTING 10' 3-WIRE (FENNER/STONE)	-	BLACK	WHITE	GREEN
7	6900405	DUMP REMOTE HARNESS SINGLE ACTING 3-WIRE (MONARCH/BUCHER)	RED	GREEN	WHITE	BLACK
8	6900406	DUMP REMOTE HARNESS DOUBLE ACTING 4-WIRE (MONARCH/BUCHER)	-	GREEN	WHITE	BLACK
9	6900342	DUMP REMOTE 4334 10' QUICK CONNECT (MONARCH/BUCHER)	-	-	-	-
10	6900086	DUMP REMOTE 4334 3' FOUR WIRE (MONARCH)	RED	GREEN	WHITE	BLACK
11	6900038	DUMP REMOTE KG11 SINGLE ACTING 10' 3-WIRE (FENNER/STONE)	-	BLACK	WHITE	GREEN



SOLENOIDS		
REF NO.	ITEM NO.	DESCRIPTION
1	6900027	SOLENOID 3-POST HD BATTERY ISOLATOR
2	6900088	SOLENOID 3-POST MONARCH K17757
3	6900041	SOLENOID 4-POST KTI, MONARCH



VALVES AND COILS		
REF NO.	ITEM NO.	DESCRIPTION
1	6900145	10V VALVE COIL DOWN SIDE (SQUARE) KTI
2	6900146	10V VALVE COIL UP SIDE (ROUND) KTI
3	6900163	VALVE 4W2P DOWN SIDE MONARCH 07193-D
4	6900162	VALVE 2W2P UP SIDE MONARCH 00455-D
5	6900244	COIL ONLY SQUARE MONARCH 07164-D
6	6900147	VALVE 2W2P FOR SQUARE VALVE COIL 6900145
7	6900148	VALVE 4W2P FOR ROUND VALVE COIL 6900146



TANKS AND CAPS		
REF NO.	ITEM NO.	DESCRIPTION
1	6900087	BREATHER CAP (MONARCH) 01143
2	6900399-01	TANK MONARCH 9" X 10" X 16" (MONARCH)
3	6900085	TANK MONARCH 6.75" X 11" (MONARCH) K14166
4	6900241	TANK MONARCH 6.75" X 15" (MONARCH) K14168
5	6900274	4 QUART PLASTIC REPLACEMENT TANK
6	6900304	8 QUART PLASTIC REPLACEMENT TANK
7	6900303	13 QUART PLASTIC REPLACEMENT TANK
8	6900306	UPPER RESERVIOR DIP STICK CAP
9	6900307	LOWER DUMP CAP REPLACEMENT W/GASKET



BODY • BATTERY & ACCESSORIES | DECALS



1



2



3

4



5



6



7



8

BATTERY & ACCESSORIES		
REF NO.	ITEM NO.	DESCRIPTION
1	6250014	BATTERY 685-AMP 12V DEEP CYCLE
2	6900003	BATTERY BOX WITH STRAP
3	7000925	BATTERY CABLE - RED 4GA
4	7000926	BATTERY CABLE - BLACK 4GA
5	6250004	SOLARPULSE 12V SOLAR CHARGER 2W MAINTAINER
6	6250005	SOLARPULSE 12V SOLAR CHARGER 5W MAINTAINER
7	6900198	BATTERY CHARGER 5-AMP 12 V PROMAR
8	6900317	BATTERY CHARGER/MAINTAINER 12 V 1.5-AMP



Decals

COMBO WARNING DECALS



All Warning Labels Listed Have Been Approved By NATM

NATM Has Developed Standard For Product Safety And Labels. This Standard Sets Forth Performance Requirements For The Design, Application, Use And Placement Of Safety Labels Intended To Identify Hazards For Persons Using, Operating, Servicing Or In Proximity Of A Trailer.

Warning Labels Are Critical Because They Represent The Final Opportunity For The Manufacturer To Communicate With The End User About The Potential Hazards Of Operating A Trailer.

6800235 • Bumper Pull Bulldog Electric Brake • Size: 10.25 X 2.75

⚠️ WARNING	⚠️ WARNING	⚠️ WARNING	⚠️ WARNING	⚠️ WARNING
<p>Uncoupling will cause trailer to come loose from tow vehicle. You must:</p> <ol style="list-style-type: none"> CHECK that ball LOAD RATING is same or greater than coupler LOAD RATING. CHECK that ball SIZE is same as coupler. CLOSE COUPLER CLAMP on ball. LIFT coupler upwards to test that it will not separate from ball. LOCK sleeve with pin or padlock. 	<p>ALWAYS use safety chains. Chains hold trailer if connection fails. You must:</p> <ol style="list-style-type: none"> CROSS chains underneath coupler. ALLOW slack for trailer to turn. ATTACH chain hooks securely to tow vehicle frame. 	<p>Trailer can roll if it comes loose. Electric safety brake applies when cable pulls pin out of switch box.</p> <ol style="list-style-type: none"> PULL hard to get pin out of switch box. CHECK brake by PULLING TRAILER with tow vehicle. ATTACH pin CABLE to tow vehicle so pin will be pulled out if trailer separates. Properly REPLACE pin in switch box. 	<p>Lights can prevent trailer from being hit by other vehicles. You must:</p> <ol style="list-style-type: none"> CONNECT trailer and tow vehicle electrical connectors. CHECK all lights: tail lights, turn signal, and brake lights. DO NOT TOW if lights are not working. 	<p>Tire, wheel or lug nut failure can cause loss of control. Before towing, you must CHECK:</p> <ol style="list-style-type: none"> Tire pressure and tread. Tires and wheels for damage. Lug nuts for tightness. For new and remounted wheels, re-tighten lug nuts at the first 10, 25 and 50 miles of driving.
	<p>ATTACH TO TOW VEHICLE FRAME</p>	<p>PIN PULLED OUT, ONLY TO TEST BRAKES</p>	<p>DISCONNECTED CONNECTED</p>	<p>Lug Nuts TIGHT?</p>
© 2002 NATM				UT0032

Combo Label: Coupling (Sleeve Latch) - Safety Chains - Breakaway - Lights - Wheel Lug Nuts & Tire Wear

BODY = DECALS

COMBO DECALS

6800234 • Bumper Pull Surge Brake • Size: 10.25 X 2.75

⚠ WARNING	⚠ WARNING	⚠ WARNING	⚠ WARNING	⚠ WARNING
<p>ALWAYS use safety chains. Chains hold trailer if connection fails. You must:</p> <ol style="list-style-type: none"> CROSS chains underneath coupler. ALLOW slack for trailer to turn. ATTACH chain hooks securely to tow vehicle frame. 	<p>Uncoupling will cause trailer to come loose from tow vehicle. You must:</p> <ol style="list-style-type: none"> CHECK that ball LOAD RATING is same as or greater than coupler LOAD RATING. CHECK that ball SIZE is same as coupler. CLOSE COUPLER CLAMP on ball. LIFT coupler upwards to test that it will not separate from ball. LOCK coupler clamp with pin or padlock. 	<p>Trailer can roll if it comes loose. Safety brake applies when chain pulls brake lever.</p> <ol style="list-style-type: none"> ATTACH brake CHAIN securely to tow vehicle so lever will be pulled if trailer separates. CHECK brake fluid level. DO NOT TOW trailer if brake fluid is NOT FULL. 	<p>Lights can prevent trailer from being hit by other vehicles. You must:</p> <ol style="list-style-type: none"> CONNECT trailer and tow vehicle electrical connectors. CHECK all lights: tail lights, turn signal, and brake lights. DO NOT TOW if lights are not working. 	<p>Tire, wheel or lug nut failure can cause loss of control. Before towing, you must CHECK:</p> <ol style="list-style-type: none"> Tire pressure and tread. Tires and wheels for damage. Lug nuts for tightness. <p>For new and remounted wheels, re-tighten lug nuts at the first 10, 25 and 50 miles of driving.</p>

Combo Label: Coupling (Sleeve Latch) - Safety Chains - Breakaway - Lights - Wheel Lug Nuts & Tire Wear

6800209 • Gooseneck Combo • Size: 8.5 X 2.75

⚠ WARNING	⚠ WARNING	⚠ WARNING	⚠ WARNING
<p>ALWAYS use safety chains. Chains hold trailer if connection fails. You must:</p> <ol style="list-style-type: none"> ALLOW slack for trailer to turn. ATTACH chain hooks securely to tow vehicle frame. 	<p>Trailer can roll if it comes loose. Electric safety brake applies when cable pulls pin out of switch box.</p> <ol style="list-style-type: none"> PULL hard to get pin out of switch box. CHECK brake by PULLING TRAILER with tow vehicle. ATTACH pin CABLE to tow vehicle so pin will be pulled out if trailer separates. Promptly REPLACE pin in switch box. 	<p>LIGHTS can prevent trailer from being hit by other vehicles. You must:</p> <ol style="list-style-type: none"> CONNECT trailer and tow vehicle electrical connectors. CHECK all lights: tail lights, turn signal, and brake lights. DO NOT TOW if lights are not working. 	<p>Tire, wheel or lug nut failure can cause loss of control. Before towing, you must CHECK:</p> <ol style="list-style-type: none"> Tire pressure and tread. Tires and wheels for damage. Lug nuts for tightness. <p>For new and remounted wheels, re-tighten lug nuts at the first 10, 25 and 50 miles of driving.</p>

Combo Label: Coupling (Sleeve Latch) - Safety Chains - Breakaway - Lights - Wheel Lug Nuts & Tire Wear

WARNING DECALS

6800207 • Check Wheels • Size: 6 X 2.25

⚠ WARNING
<p>Tire, wheel or lug nut failure can cause loss of control. Before towing, you must CHECK:</p> <ol style="list-style-type: none"> Tire pressure and tread. Tires and wheels for damage. Lug nuts for tightness. <p>For new and remounted wheels, re-tighten lug nuts at the first 10, 25 and 50 miles of driving.</p>

6800205 • Safe Coupling • Size: 6 X 2.25

⚠ WARNING	
<p>Uncoupling will cause trailer to come loose from tow vehicle. You must:</p> <ol style="list-style-type: none"> CHECK that ball LOAD RATING is same as or greater than coupler LOAD RATING. CHECK that ball SIZE is same as coupler. CLOSE COUPLER CLAMP on ball. LIFT coupler upwards to test that it will not separate from ball. LOCK coupler clamp with pin or padlock. 	

6800208 • Safe Coupling • Size: 6 X 2.25

⚠ WARNING	
<p>Uncoupling will cause trailer to come loose from tow vehicle.</p> <ol style="list-style-type: none"> CHECK that pintle LOAD RATING is same or greater than ring LOAD RATING. LOCK the clamp in place using a pin or lock. 	

6800206 • Safe Loading • Size: 6 X 2.25

⚠ WARNING	
<p>Improper loading can cause trailer sway and sudden loss of control. You must:</p> <ul style="list-style-type: none"> Make certain weight of load plus trailer weight does not exceed trailer's capacity (GVWR-Gross Vehicle Weight Rating). Load heavier items in front of wheels. Load evenly side to side. SECURE load to trailer. 	

6800227 • Surge Brake • Size: 6 X 2.25

⚠ WARNING	
<p>Trailer can roll if it comes loose. Safety brake applies when chain pulls brake lever.</p> <ol style="list-style-type: none"> ATTACH brake CHAIN securely to tow vehicle so lever will be pulled if trailer separates. CHECK brake fluid level. DO NOT TOW trailer if brake fluid is NOT FULL. 	

BODY • DECALS

WARNING DECALS

6800238 • Safety Chains • Size: 6 X 2.25

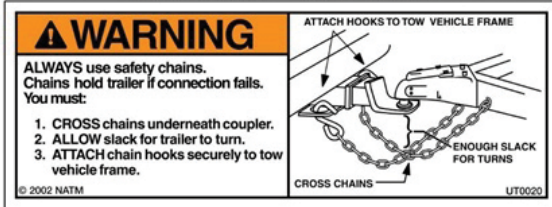

6800236 • Safety Chains • Size: 6 X 2.25

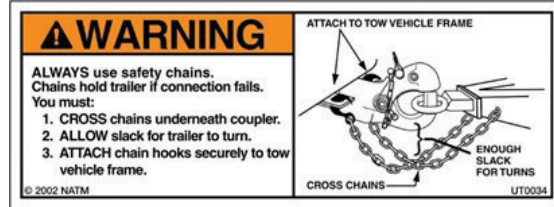

6800204 • Size: 5.75 X 2.75

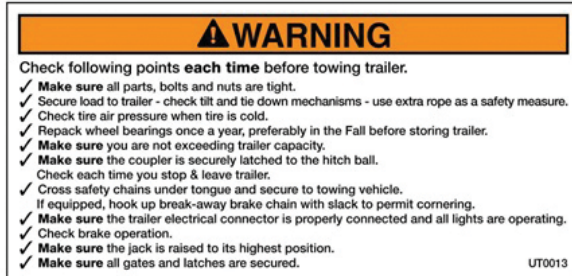

6800200 • Size: 3 X 3



6800203 • Size: 3.25 X 2.5

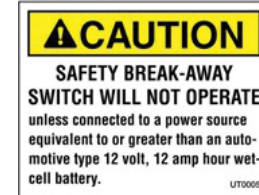

6800201 • Size: 3 X 3



6800202 • Size: 3.25 X 2.5



Bonding Tape

3M VHB™ Tapes



- Bond on contact with no drying time or fixturing
- Save processing steps and cost for drilling, screwing, welding, clean-up, and refinishing
- Easy-to-apply with minimal training and no investment in expensive application equipment



3M VHB TAPE

REF NO.	ITEM NO.	DESCRIPTION
1	6850006	VHB TAPE WHITE 3/4" X 36 YD .045 MIL 4622 (12-ROLLS)
1	6850001	VHB TAPE WHITE 1" X 36 YARDS .045 THICK 4622 (2-ROLLS)
1	6850005	VHB TAPE 3/4" X 36 YARDS .062 THICK 4624 (3-ROLLS)
2	6850010	VHB TAPE GREY 3/4" X 36 YARDS .045 THICK 4941 (3-ROLLS)
2	6850011	VHB TAPE GREY 1" X 36 YARDS .045 THICK 4941 (2-ROLLS)

BODY = DUMP CONVERSION HOISTS & SUBFRAMES

VENCO SUBFRAME FEATURES:

- Perfectly sized for a 60" CA Chassis with easy bolt on extensions for 84" CA's.
- Hoist body prop, rear hinge, fully assembled in subframe.
- Rocker style hinges accommodate structural or trapezoidal body longills.
- Integrated bolt on power unit mounting brackets and front crossmember.
- Easy bolt on hoist attachment in 45° or 50° dumping positions.
- Adaptable body guides accommodate longitudinal or trapezoidal body longills.
- Shear plate mounting kits with matching Ford Super Duty hole patterns.
- Urea tank filler knock-outs.



ALL VC HOIST CAN BE REVERSE-MOUNTED AS REQUIRED.



1

VENCO CONVERSION HOISTS FOR CAB/CHASSIS TRUCKS

REF NO.	ITEM NO.	ID NO.	DESCRIPTION
1	7900012	VC516SF-ES	HOIST SUBFRAME SYSTEM WITH SINGLE ACTING ELECTRIC PUMP
2	7900029	VC516SF-ED	HOIST SUBFRAME SYSTEM WITH DOUBLE ACTING ELECTRIC PUMP

- SUBFRAME RAIL HEIGHT 4"
- SUBFRAMES WORK WITH VENCO 416, 516, 520 AND 620 HOISTS.



2

VC516SF-E Features

- 5" Bore x 16 Stroke Cylinder
- Fits 8' - 12' Bodies, 29.5" and 34" Truck Frames
- 5.75" Mounting Height
- 7" Subframe Mounting Height
- 8 - 17 Ton Capacity
- NTEA Class - C/20
- 3,000/1,000 psi Operating Pressure

CUT THE CORD!

**Ask your representative
about the wireless remote
control for 2015 and newer
KTI Hydraulic Pumps.
Mount the antenna, plug in
the cords and go!**

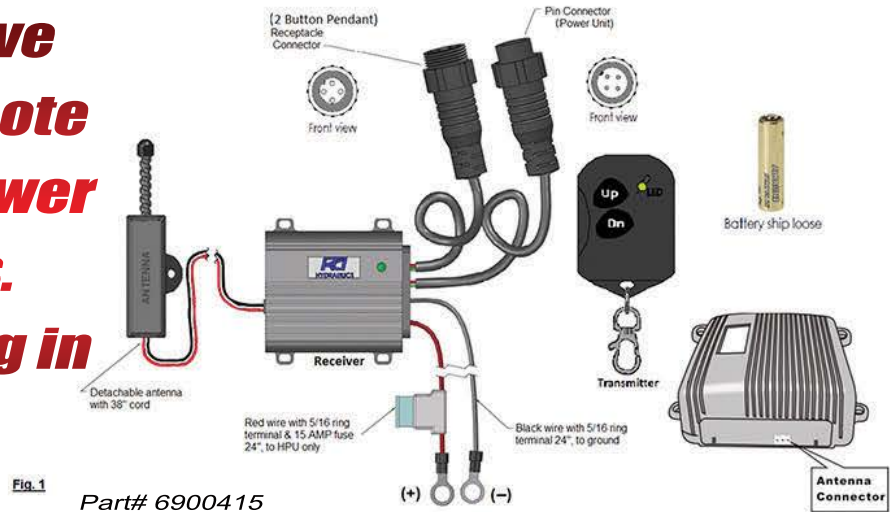



TRUCK & TRAILER HARDWARE

Buyers Truck & Trailer Hardware has what you need to complete your truck or trailer.

LANDSCAPE ACCESSORIES

FOLDING FOOT/GRAB STEP

2 RUNG CABLE STEP

DUMP BODY VIBRATORS

WSTAINLESS STEEL TAILGATE LATCH

GAS SPRING DOOR HOLDERS

